

# Think Tank Think ENDURATANK

NEED  
MORE HELP?  
CALL US ON  
**01778  
562810**



## 4200 LITRE 15° CONE TANK TECHNICAL SPECIFICATION

CODE	17521215-F	STANDARD OUTLET	2"
CAPACITY (Litres)	4200	CAPACITY (Gallons)	923

A (mm)	1900	B (mm)	620
C (mm)	1944	D (mm)	2334

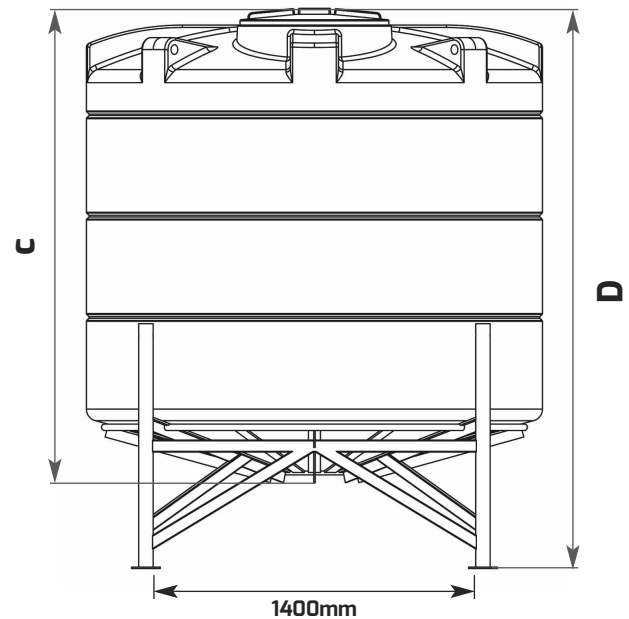
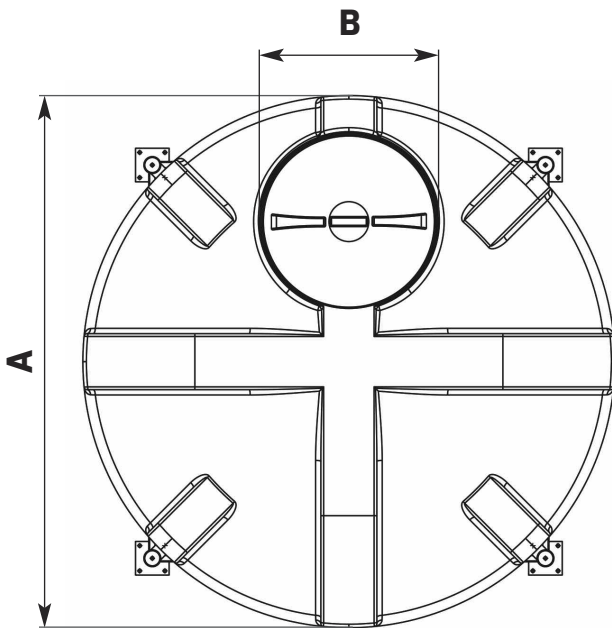

Please note: Tank sizes quoted are subject to a +/- 3% variation. Drawings not to scale.

# ENDURATANK®

A Division of ENDURAMAXX

© Enduramaxx 2018. Copyright of this drawing is reserved by Enduramaxx. The issue of this drawing is confidential disclosure of its contents, and is made conditional that it is neither disclosed to a third party, nor any item described herein and designed by Enduramaxx is produced either in whole or in part without the written consent of Enduramaxx.

Enduratank is a Registered Trading Name of Enduramaxx Limited



**01778 562810**    [sales@enduratank.co.uk](mailto:sales@enduratank.co.uk)

Visit us at [www.enduratank.co.uk](http://www.enduratank.co.uk)