

Think Tank Think ENDURATANK

NEED
MORE HELP?
CALL US ON
01778
562810



900 LITRE 60° CONE TANK TECHNICAL SPECIFICATION

CODE	17520460-F	STANDARD OUTLET	2"
CAPACITY (Litres)	900	CAPACITY (Gallons)	197

A (mm)	1400	B (mm)	455
C (mm)	1372	D (mm)	1681

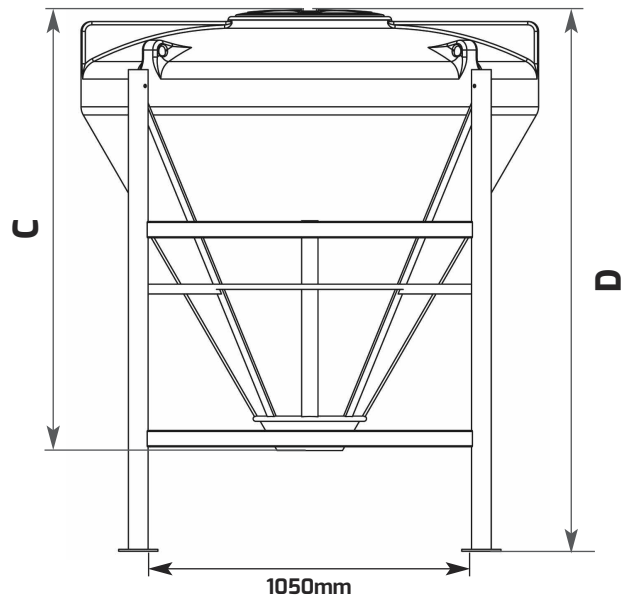
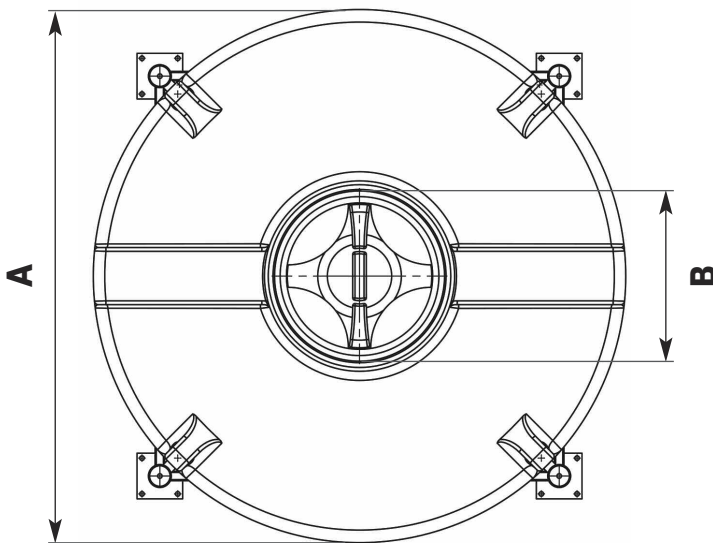

Please note: Tank sizes quoted are subject to a +/- 3% variation. Drawings not to scale.

ENDURATANK®

A Division of ENDURAMAXX

© Enduramaxx 2018. Copyright of this drawing is reserved by Enduramaxx. The issue of this drawing is confidential disclosure of its contents, and is made conditional that it is neither disclosed to a third party, nor any item described herein and designed by Enduramaxx is produced either in whole or in part without the written consent of Enduramaxx.

Enduratank is a Registered Trading Name of Enduramaxx Limited



01778 562810 sales@enduratank.co.uk

Visit us at www.enduratank.co.uk